

# CHILLKING

## Chiller Systems

### MODEL GV24CK1

**SPECIFICATIONS:**

- 24,000 BTU/HR at 95F degree ambient and 55F degree water out
- Electrical: 208/230V, 60hz single phase
- Minimum Circuit Ampacity: 23, Maximum Fuse Size 35 Amps
- One 30 gallon stainless steel tank with Chilling evaporator coil inside
- 1/2 HP water pump: 22 GPM max, 36 PSI max
- R410a Refrigerant
- One 24,000 BTU/HR Copeland scroll compressor
- Approximate shipping weight 700 LBS
- Dimensions: 35" wide, 35" long, 62" tall
- Decibels: 75

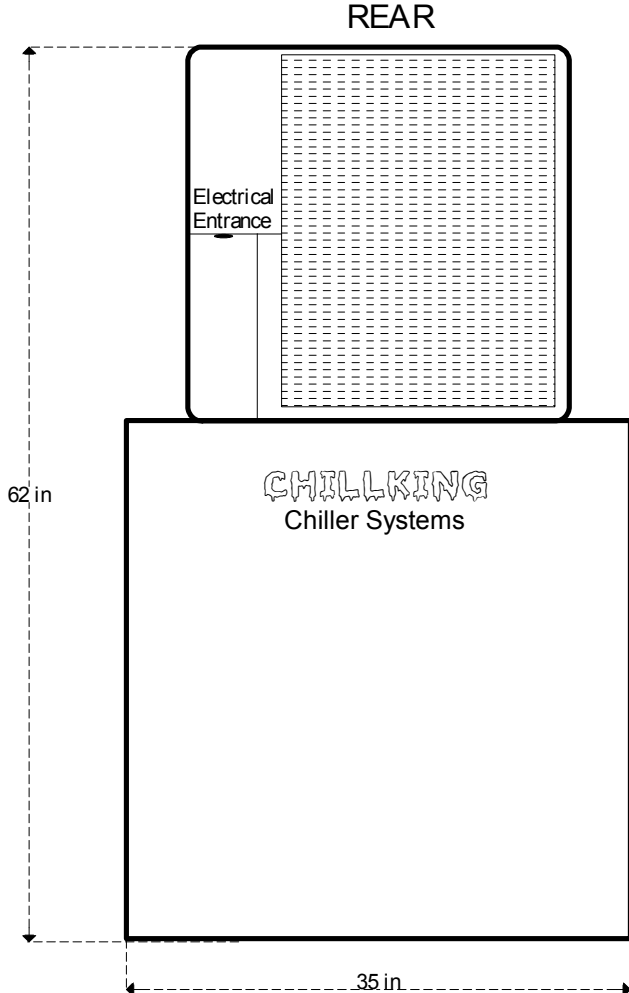
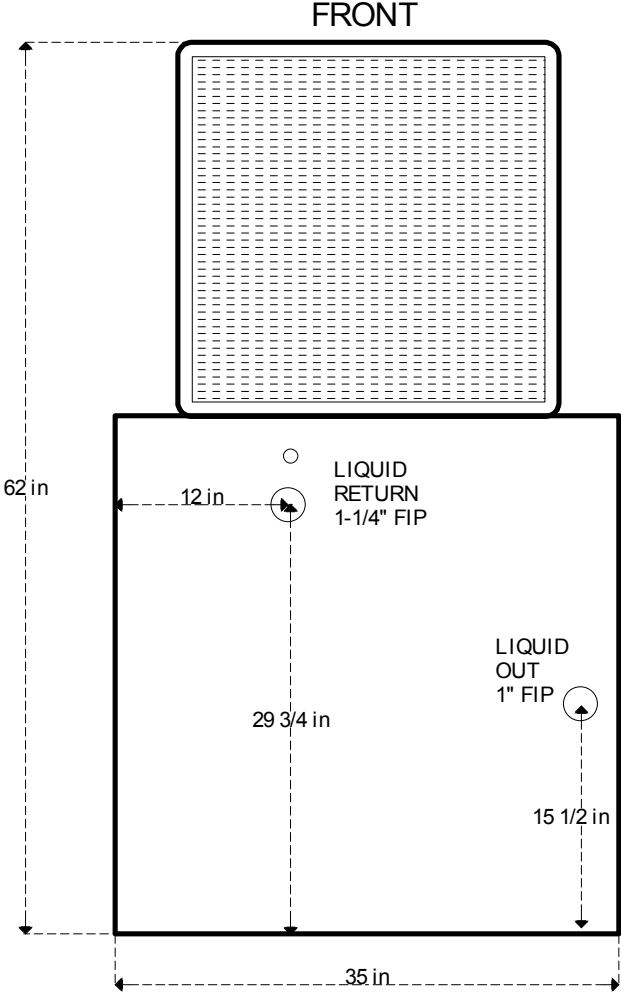
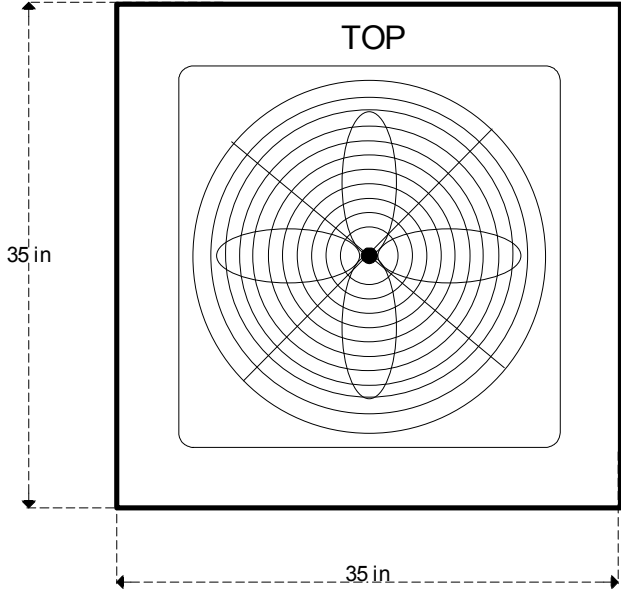

# CHILLING

## Chiller Systems

### Wiring Diagram

### Vertical Single Circuit Single Phase

