

# CHILLKING

## Chiller Systems

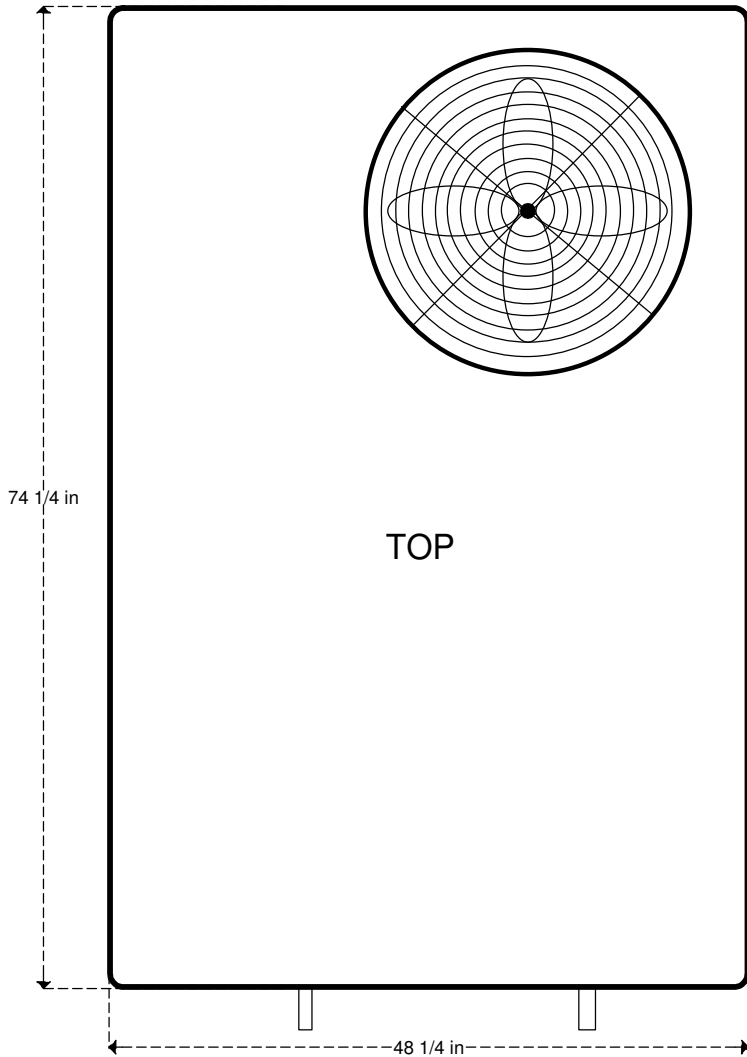

### MODEL GC60CK4

#### SPECIFICATIONS:

- 60,000 BTU/HR at 95F degree ambient and 55F degree water out
- Electrical: 460V, 60hz three phase
- Minimum Circuit Ampacity: 13, Maximum Fuse Size 20 Amps
- One 44 gallon stainless steel tank with Chillking evaporator coil inside
- 1 HP water pump: 47 GPM max, 49 PSI max
- R410a Refrigerant
- One 60,000 BTU/HR Copeland scroll compressor
- Approximate shipping weight 900 LBS
- Dimensions: 48-1/4" wide, 74-1/4" long, 38-3/4" tall
- Decibels: 78

#### FRONT

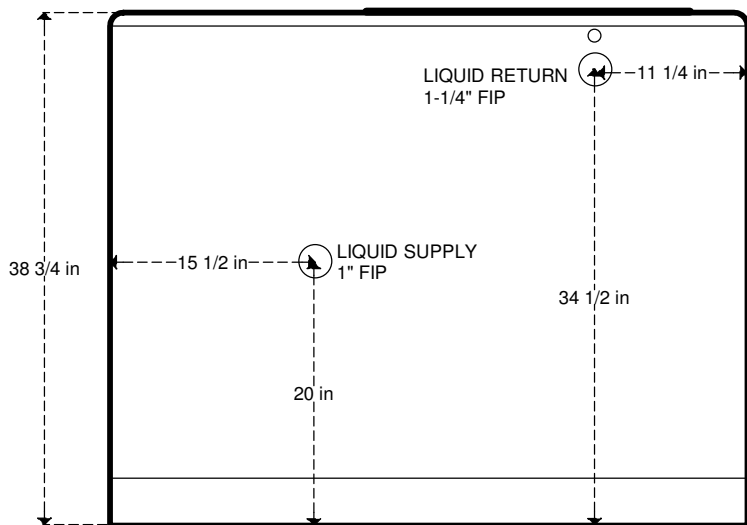

#### REAR

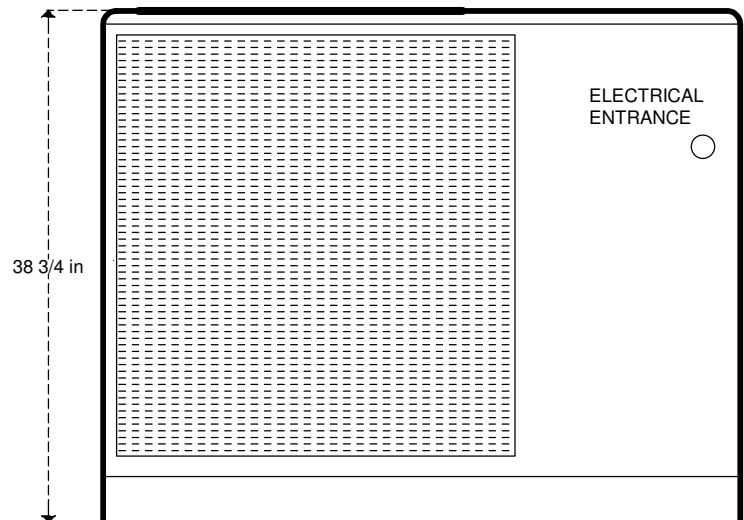

# CHILLING

## Chiller Systems

### Wiring Diagram

### 460v Three Phase

