

CHILLKING

Chiller Systems

MODEL GC240CK3

TOP

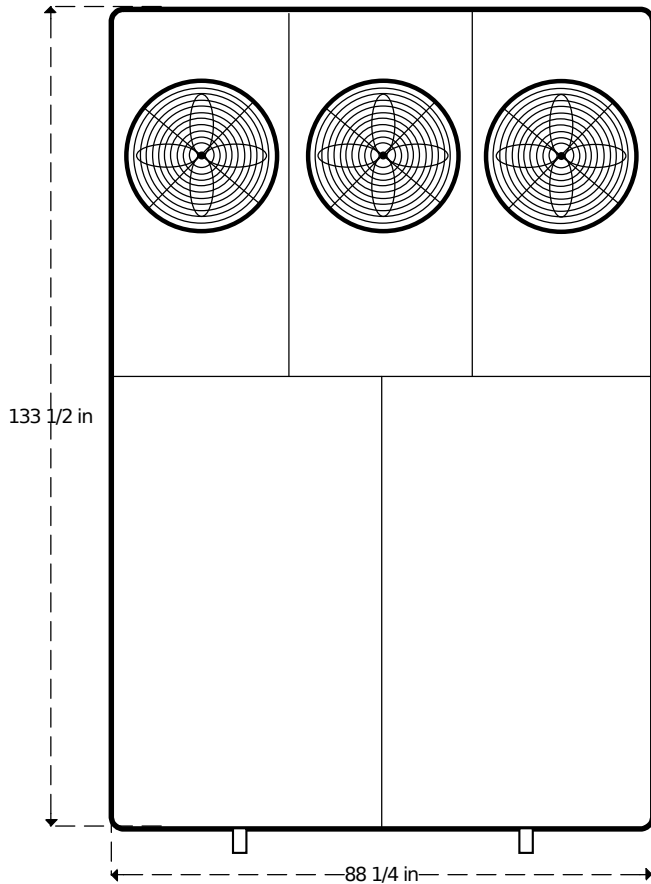

SPECIFICATIONS:

- 240,000 BTU/HR at 95F degree ambient and 55F degree water out
- Electrical: 208/230V, 60hz three phase
- Minimum Circuit Ampacity: 91, Maximum Fuse Size 125 Amps
- 146 gallon stainless steel tank with Chillking evaporator coils inside
- 1-1/2 HP water pump: 59 GPM max, 51 PSI max
- R410a Refrigerant
- Two 120,000 BTU/HR Copeland scroll compressor
- Approximate shipping weight 2,300 LBS
- Dimensions: 88-1/4" wide, 133-1/2" long, 50-1/2" tall
- Decibels: 88

END

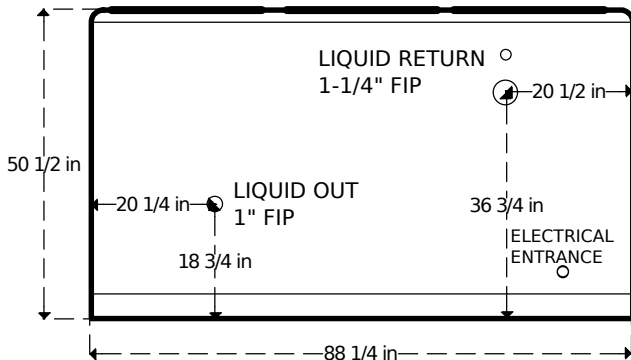

SIDE

