

CHILLKING

Chiller Systems

TOP

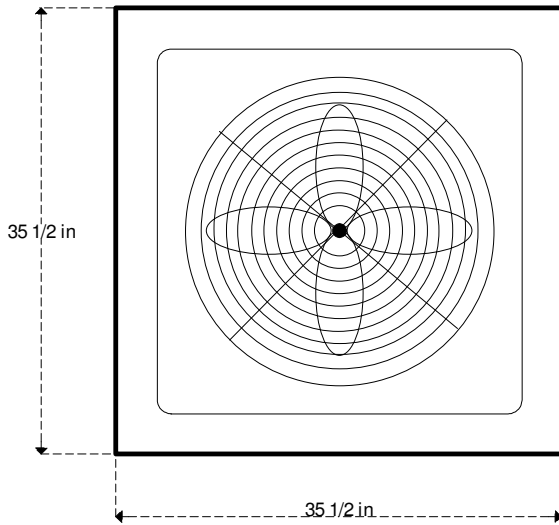

MODEL GV90CK3

SPECIFICATIONS:

- 90,000 BTU/HR at 95F degree ambient and 55F degree water out
- Electrical: 208/230V, 60hz three phase
- Minimum Circuit Ampacity: 45, Maximum Fuse Size 69 Amps
- One 77 gallon stainless steel tank with Chilling evaporator coil inside
- 1 HP water pump: 47 GPM max, 49 PSI max
- R410a Refrigerant
- One 90,000 BTU/HR Copeland scroll compressor
- Approximate shipping weight 1,000 LBS
- Dimensions: 35-1/2" wide, 35-1/2" long, 83-1/2" tall
- Decibels: 84

FRONT

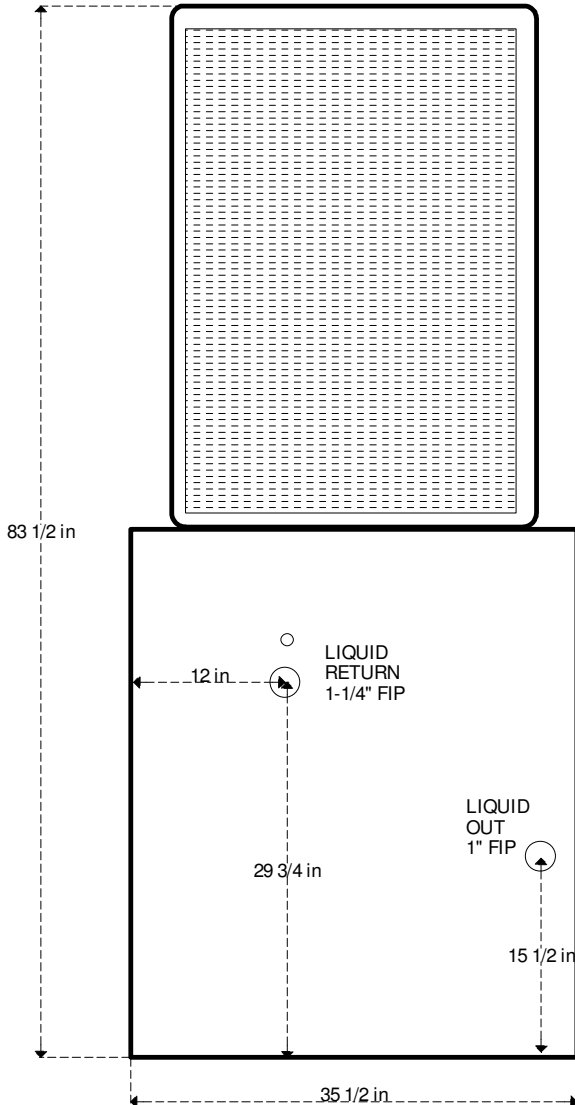

REAR

