

DehuKing

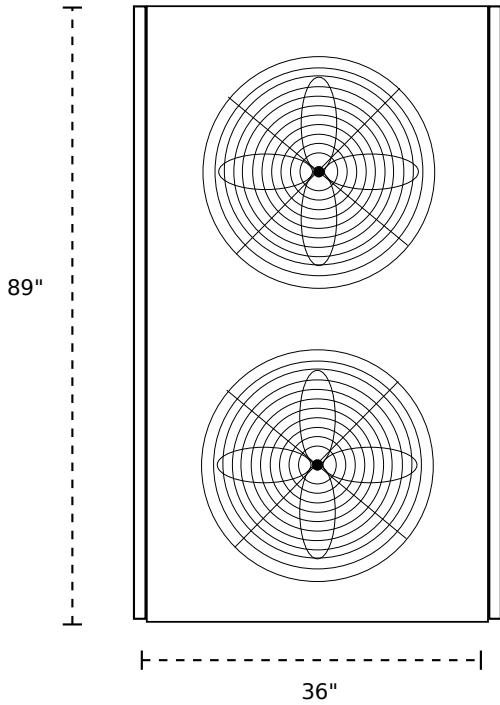

MODEL DU12T18UV432-3

TOP



SPECIFICATIONS:

- 12 ton dehumidifier
- 18 gallons per hour, 432 gallons per day
- 13.65 pints per KW
- Ultraviolet purification
- Electrical: 208/230V, 60hz three phase
- Minimum Circuit Ampacity: 55, Maximum Fuse Size 77 Amps
- R410a Refrigerant
- Two 72,000 BTU/HR Copeland Scroll Compressors
- Dimensions: 89" wide, 36" long, 77" tall
- Decibels: 84

SIDE

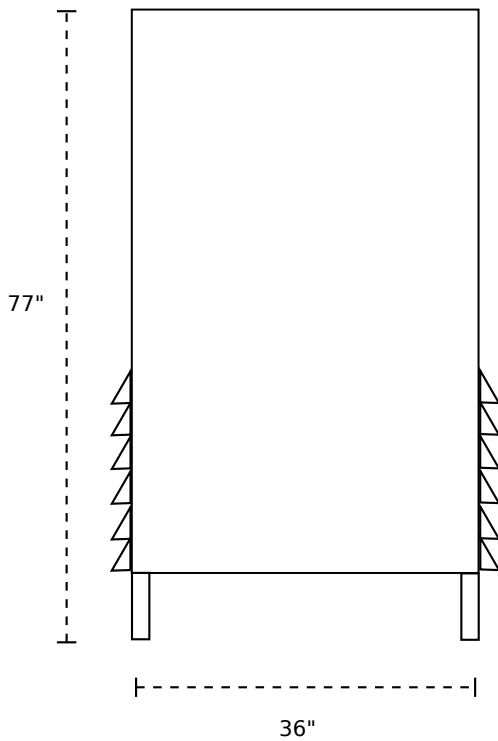

FRONT

