

DehuKing

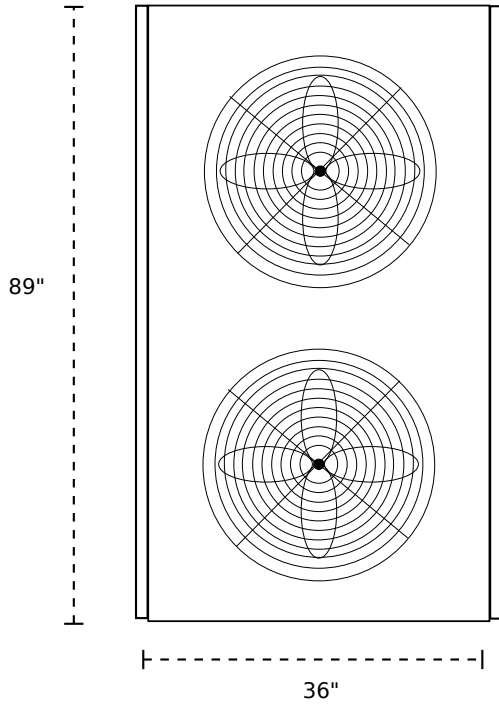

MODEL DU07T11UV264-3

TOP



SPECIFICATIONS:

- 7 ton dehumidifier
- 11 gallons per hour, 264 gallons per day
- 14.35 pints per KW
- Ultraviolet purification
- Electrical: 208/230V, 60hz three phase
- Minimum Circuit Ampacity: 33, Maximum Fuse Size 45 Amps
- R410a Refrigerant
- Two 60,000 BTU/HR Copeland Scroll Compressors
- Dimensions: 89" wide, 36" long, 72" tall
- Decibels: 84

SIDE

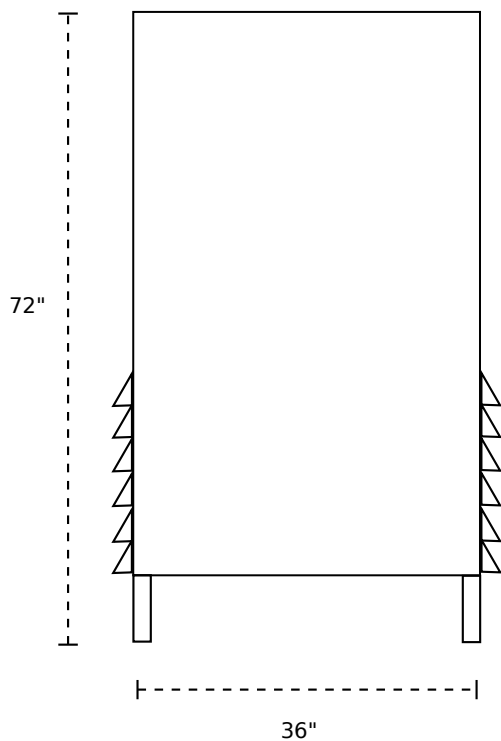

FRONT

